

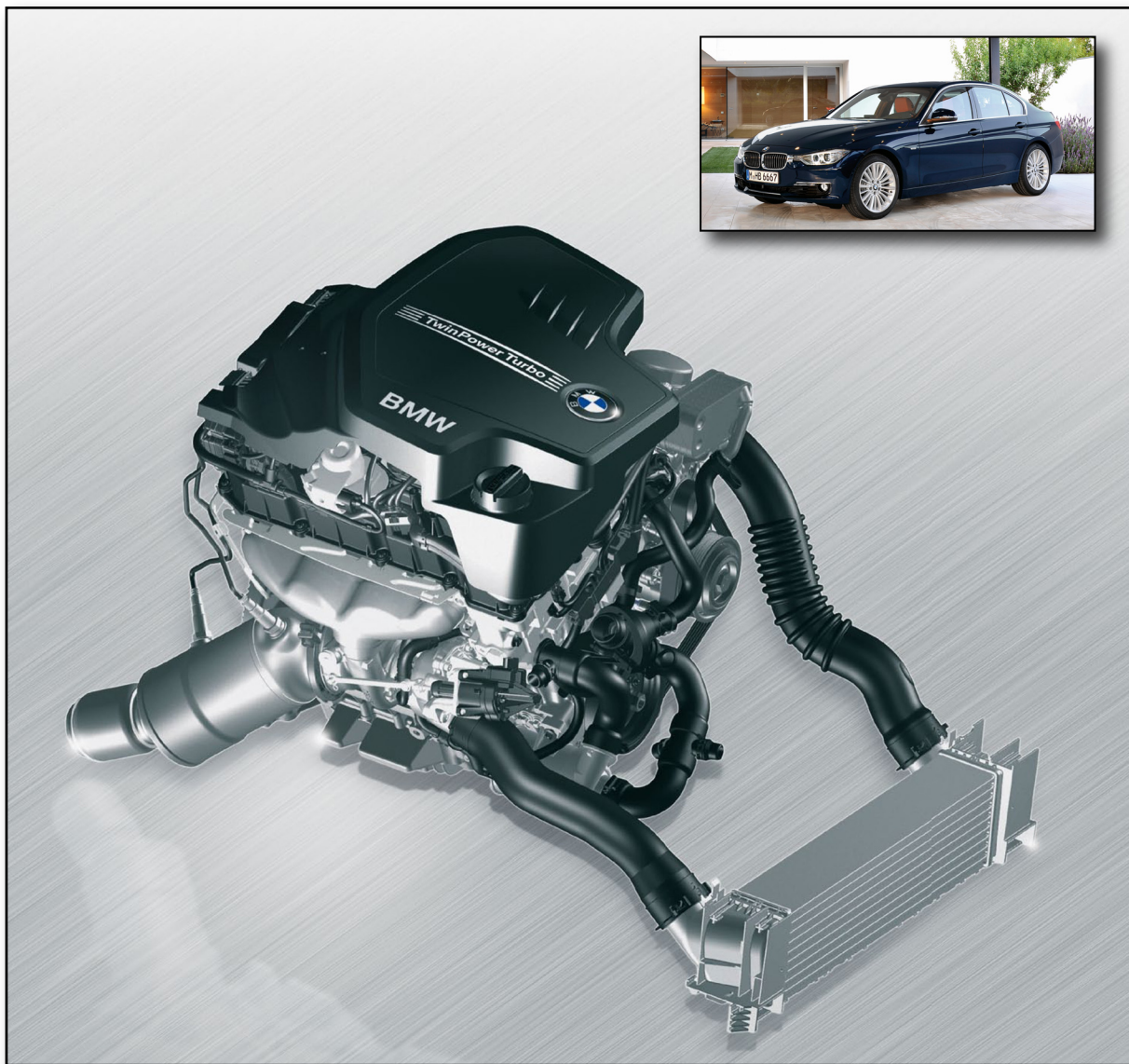

# BMW Technical Training

## N26 Engine



**Information Status:** September 01, 2012

**Course Code:** ST1215 N26 Engine

The information contained in the training course materials is solely intended for participants in this training course conducted by BMW Group Technical Training Centers, or BMW Group Contract Training Facilities.

This training manual or any attached publication is not intended to be a complete and all inclusive source for repair and maintenance data. It is only part of a training information system designed to assure that uniform procedures and information are presented to all participants.

For changes/additions to the technical data, repair procedures, please refer to the current information issued by BMW of North America, LLC, Technical Service Department.

This information is available by accessing TIS at [www.bmwcenternet.com](http://www.bmwcenternet.com).

---

# Table of Contents

## N26 Engine

Subject	Page
<b>Introduction</b> .....	<b>3</b>
N26 Engine .....	3
History .....	4
N26 Engine Features .....	4
Technical Data .....	5
Horse Power and Torque Diagram .....	6
Engine Components/Systems Overview .....	7
Engine Identification .....	8
Engine Designation .....	8
Engine Identification and Number .....	9
<b>N26 Specific Components</b> .....	<b>10</b>
Cylinder Head Cover .....	10
High Pressure Fuel Pump .....	11
Fuel Injectors .....	12
Fuel Line .....	13
Fuel System Overview .....	14
Turbocharger .....	15
Exhaust Turbocharger .....	15
Exhaust System .....	16
Catalytic Converter .....	16
Additional Emission Reduction Measures .....	17
HC Fleece .....	17
Cooling System .....	17
System Overview .....	18
Driving Performance and Fuel Consumption .....	19

---

# **N26 Engine**

**Model: F30**

**Production: From 03/2012**

# **OBJECTIVES**

After completion of this module you will be able to:

- Describe the features of the N26B2000 engine
- Describe the specifications of the N26B2000 engine

# Introduction

## N26 Engine

The N26 engine is the third generation of the BMW SULEV engines used in the US market. The N26 shares many technical features with the current N20 engine. This engine is currently available in the F30 328i as of 3/2012. The new N26 engine is the first turbocharged SULEV gasoline engine worldwide that requires no secondary air system.

This not only means that the BMW Group is complying with the requirements of the world's most stringent exhaust emission legislation, but also underlines the fact that the term **“premium”** is being defined by the many facets of substantiality to an ever increasing extent. Twin Power Turbo technology enables dynamic performance and achievement of low fuel consumption while adhering to the most stringent exhaust emission limits.

### N26B2000 engine



Models with the N26 engine were launched to the US market in the March 2012.

Model	Model series	Engine	Power output in kw/bhp	Torque in Nm
328i	F30	N26B2000	180/240	350

### Emission Label



### History

The following chart list all previous BMW SULEV gasoline engines.

Engine	Model	Model series	Displacement in liters	Power output in kW/bhp	Torque in Nm	Engine control system	Introduced-discontinued
M56B25	328iA	E46 Coupe Sedan Sportwagon	2.5	135kW (184 hp)	237 Nm	MS 43	2003-2006
N51B30	128i 128i 328i / 328ix	E82 E88 E90/92/93	3.0	170 kW (230 hp)	271 Nm	MSV80.1	MY 2008-2012 MY 2008-2012 MY 2006-2011

### N26 Engine Features

The N26 engine also shares many features with the N20 engine, such as the cylinder head, valvetrain, engine block, crankshaft, pistons. Over 95% of the N26 engine is carried over from the N20.

By using the latest technology TVDI (Turbocharged Valvetronic Direct Injection) in conjunction with a TwinScroll exhaust turbocharger, it is now possible to decrease emissions substantially, while at the same time maintaining the same power output as the N20.

## Technical Data

		<b>N26B2000</b>	<b>N20B2000</b>
Type		4 cyl.	4 cyl.
Firing order		1- 3- 4- 2	1- 3- 4- 2
Displacement	[cm <sup>3</sup> ]	1997	1997
Bore / stroke	[mm]	84/90	84/90
Power output at engine speed	[kW/bhp] [rpm]	180/240 5000 - 6500	180/240 5000 - 6500
Torque at engine speed	[Nm/lb-ft] [rpm]	350/258 1250 - 4800	350/258 1250 - 4800
Power output per liter	[kW/l]	90.14	90.14
Cutoff speed	[rpm]	7000	7000
Compression ratio		10.0 : 1	10.0 : 1
Valves per cylinder		4	4
Diameter of intake valve	[mm]	32	32
Diameter of exhaust valve	[mm]	28	28
Diameter of connecting rod bearing inside diameter	[mm]	144.35	144.35
Engine control system		MEVD 17.2.9	MEVD 17.2.4 up to 07/12 MEVD 17.2.9 from 07/12
Exhaust emission standard US		SULEV	ULEV II

# Horse Power and Torque Diagram

Full load diagram for the N26B20 engine, compared with the N55B30 engine

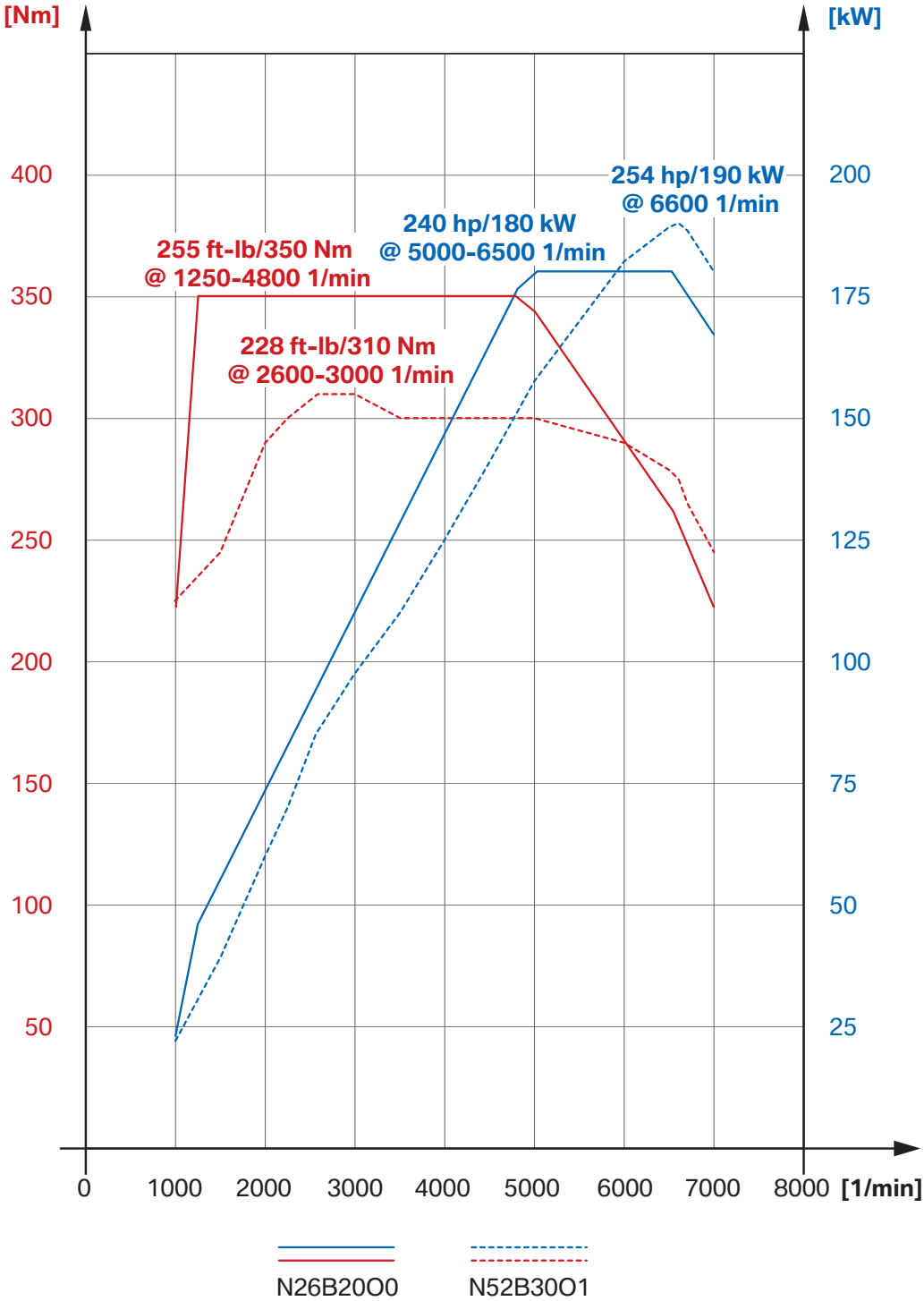



---

## Engine Components/Systems Overview

The following provides an overview of the features of the N26 engine:

- **Engine block**

Same as N20

- **Crankshaft**

Same as N20

- **Valve train**

Same as N20

- **Camshaft**

Same as N20

- **Belt drive**

Same as N20

- **Oil supply**

Same as N20

- **Crankcase ventilation**

The N26 engine uses the same crankcase ventilation principle as N20 engine. The main difference is that the pressure regulating valve is now welded to the cylinder head cover. This is now considered hydrocarbon emissions tight.

- **Cooling system**

Same as N20

- **Evaporative system**

Same as N20

---

- **Air intake and exhaust system**

The air intake and exhaust systems differ slightly on the N26 engine. There is an additional HC filter located in the air filter box to capture hydrocarbon emissions. The exhaust turbocharger is identical to the N20 but now incorporates an electric wastegate valve actuator.

**Note: As of 07/2012 all N20 engines will have electric wastegates.**

- **Secondary air system**

Not required

- **Vacuum system**

Vacuum reservoir no longer integrated into engine cover.

- **Fuel system**

Bosch HDEV5.2 solenoid valve injector is an inward-opening multi-hole valve. These injectors are identical to the N55 and N20 from a technical point of view. The N26 injectors are referred to as “**sorted**”, which means that they are less prone to leakage. The leakage is <0.5mm<sup>3</sup>/min @20MPa. (200bar)

- **Engine electrical system**

Engine management MEVD17.2.9 is used with the N26 engine with new internal programming.

Adaption algorithm for continuous injector individual measurement of the opening and closing time. (flight phase of the injector needle) by characteristics of the current signal.

Higher precision of the injected fuel quantity, especially required for ‘double’ injection for heating-up of catalytic converter.

Engine wire harness modification , due to electric wastegate.

**Note: All N20 engines will receive MEVD17.2.9 starting with 07/12 production.**

## **Engine Identification**

### **Engine Designation**

In the technical documentation, the engine designation is used to ensure the clear identification of engines.

The N26 engine is available in the following version: **N26B2000**

In the technical documentation, you will also find the short form of the engine designation N26 which only permits identification of the engine type.

The following chart explains the meaning of each component of the engine designation.

Index	Explanation
N	BMW Group "New generation"
2	4-cylinder engine
6	Engine with exhaust turbocharger, Valvetronic and direct fuel injection (TVDI)
B	Gasoline engine
20	2.0 liters displacement
O	Upper performance class
0	New development

### Engine Identification and Number

To ensure clear identification and classification, the engines have an identification mark on the crankcase. This engine identification is also necessary for approval by the authorities.

Decisive here are the first seven positions. The N26 engine has an engine identification that complies with the new standard, in which the first six positions are the same as the engine designation. The seventh position is a consecutive letter that can be used for various distinctions, e.g. power stage or exhaust emission standard. A general assignment is not possible, but an "A" usually means the basic model.

The engine number is a consecutive number that permits unmistakable identification of each individual engine. The engine designation and number are on the crankcase behind the bracket for the air conditioning compressor.

**N20**



**N26**



## N26 Specific Components

### Cylinder Head Cover

The cylinder head covers are made of plastic. They accommodate the oil separation of the crankcase ventilation. The oil separators are made of plastic and are very similar to those in the N20 engine. The major change to the cylinder head cover is that the crankcase pressure regulating valve is now welded to the cover and no longer to be replaced separately.

N26

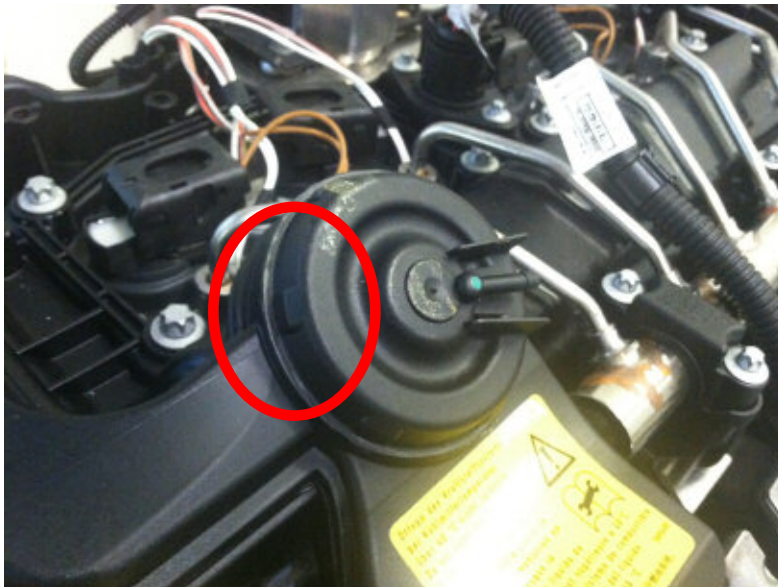

N20



# High Pressure Fuel Pump

The maximum system pressure remains the same as the N20 at 200bar. The HP pump has been slightly redesigned for the N26 engine. It has been modified by adding a groove in the outlet valve of the high pressure pump. This allows the high fuel pressure to be reduced in a short amount of time when the engine is shut off. This reduces the risk of internal and external fuel leakage.

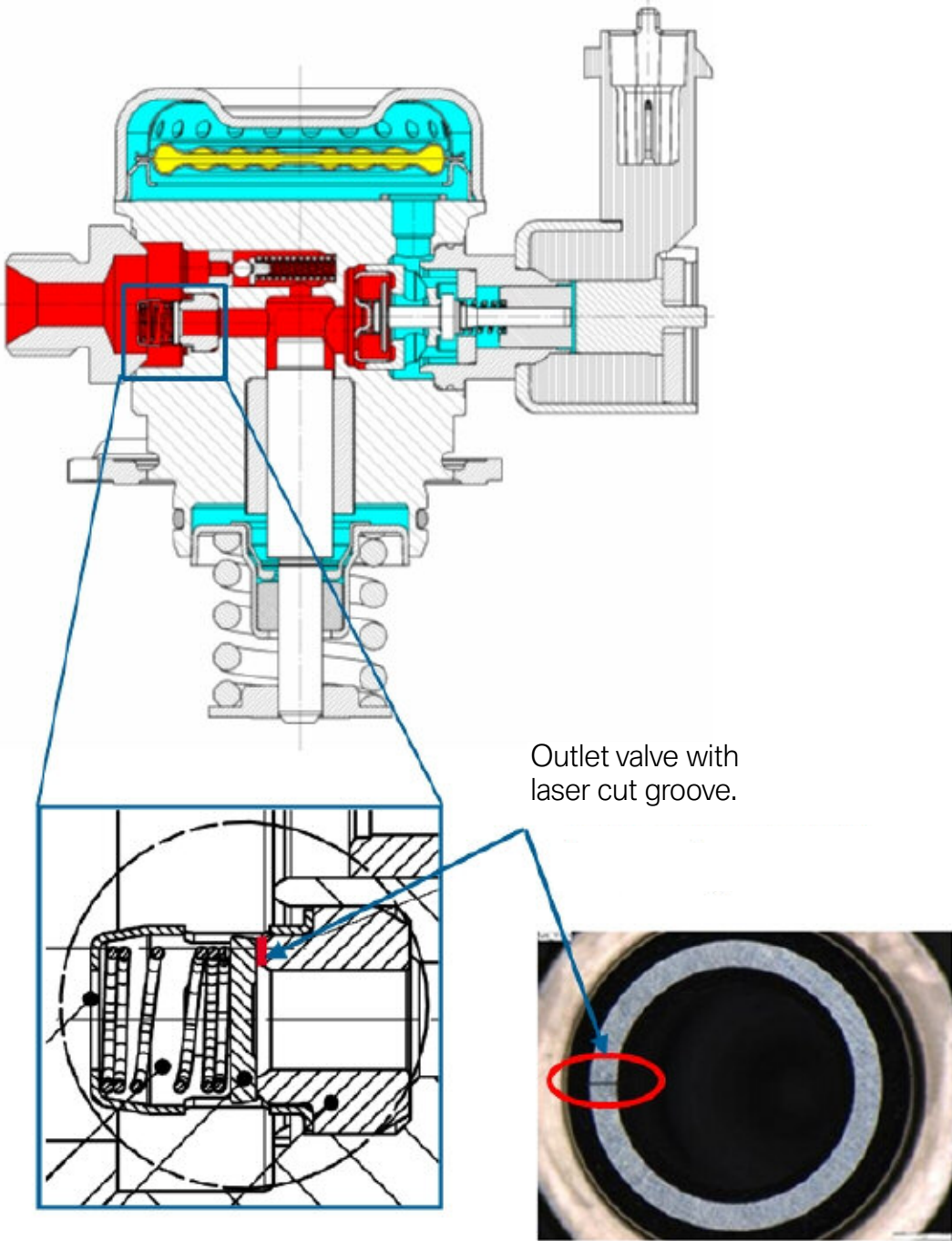

# Fuel Injectors

The fuel injectors used in the N26 are identical to the N20 and N55 from a technical point of view. The major difference is the N26 injectors are hand selected after they have been tested to insure they have the minimum amount of leakage. These are referred to as **“Sorted”** fuel injectors. They have a leakage rate of <math><0.5\text{mm}^3/\text{min}</math> @20MPa.

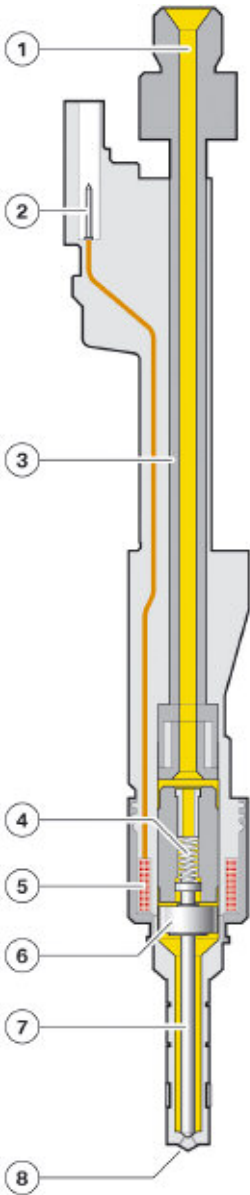

Index	Explanation
1	Fuel line connection
2	Electrical connection
3	Stem
4	Compression spring
5	Solenoid valve
6	Armature
7	Nozzle pintle
8	6-hole nozzle



## Fuel Line

The fuel lines have been modified to insure that no leakage occurs. The low pressure line from the fuel tank to the engine compartment is made of plastic (polyamide). The line from the engine compartment to the HP pump is corrugated pipe made of stainless steel, this is designed to prevent hydrocarbon evaporation and leaks. The corrugated pipe is protected by a layer of rubber that looks like a regular fuel hose.

### N26



Quick connection on fuel line in engine compartment. This line connects to plastic fuel line to the fuel tank.



### Fuel line construction

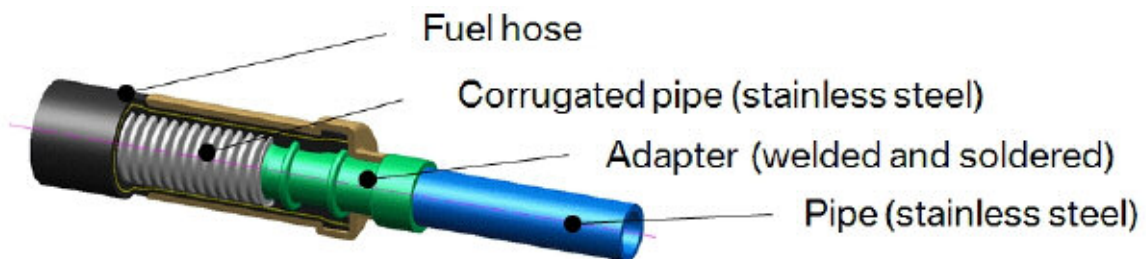

### N20



## Fuel System Overview

The fuel tank and evaporative system are basically the same as the a non SULEV vehicle.

The only difference is the connections at the tank have been modified to reduce leakage.

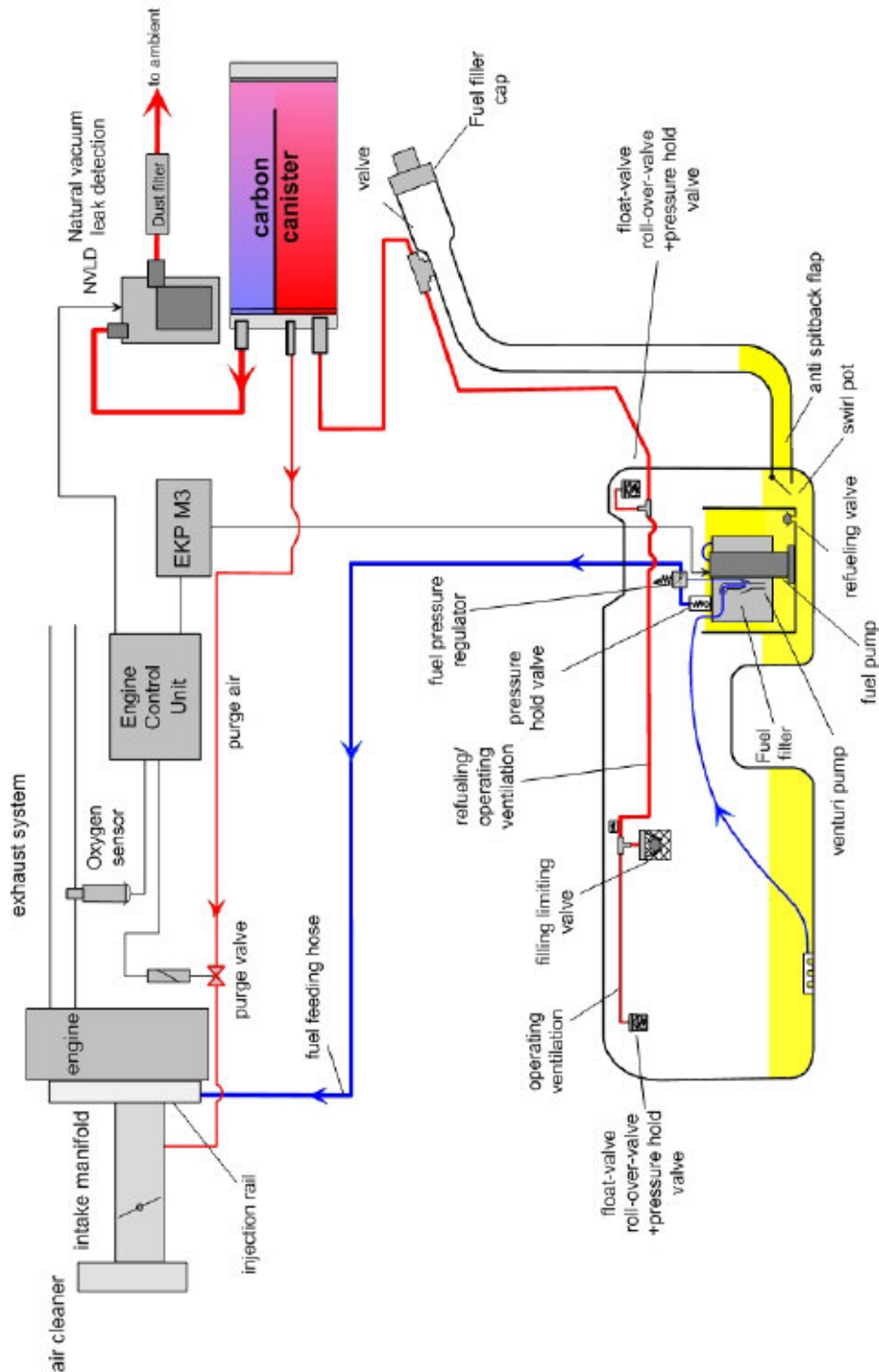



---

## Turbocharger

### Exhaust Turbocharger

The turbocharger on the N26 engine is identical to the N20. The only difference is that N26 uses an electric wastegate actuator. This is required to assist in the rapid heating of the catalytic converter to meet SULEV emission requirements.

**All N26 from SOP and N20 from 7/2012 production**

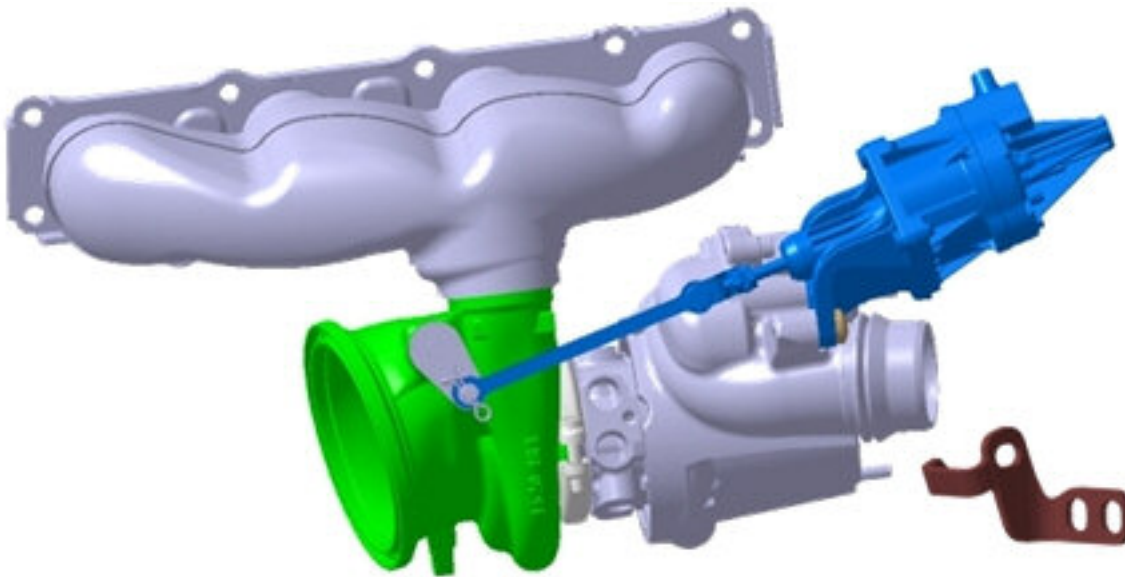

**N20 up to 7/2012**

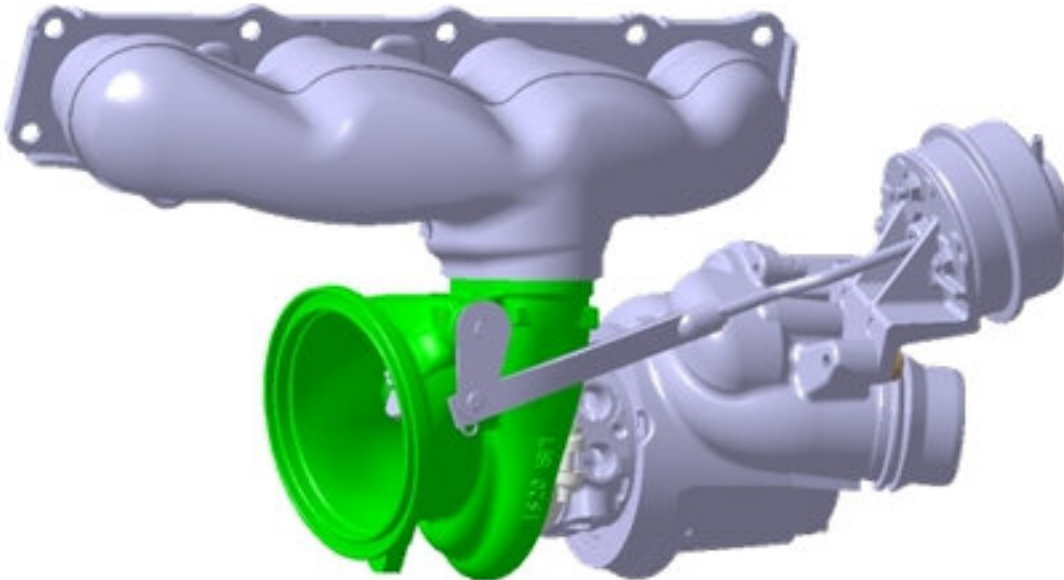

---

## Exhaust System

### Catalytic Converter

Fitted in close proximity to the engine, the close-coupled catalytic converter has been designed as a two-stage construction (first monolith: 900 cpsi, second monolith: 600 cpsi) “Cells Per Square Inch”. The catalytic converter used on the N20 uses 600 cpsi on the first monolith and 400 cpsi on the second.

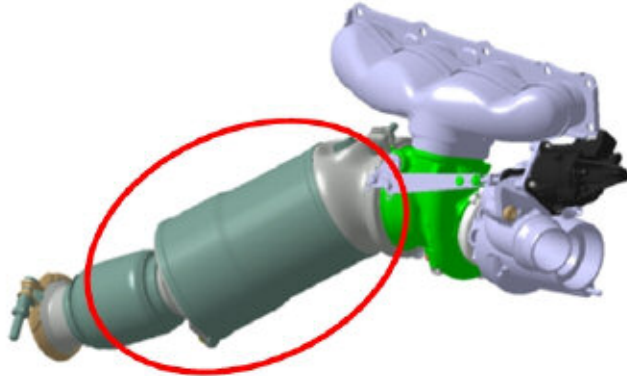

There is an additional catalytic converter located under the vehicle downstream of the exhaust. This converter is not monitored and contains 400 cpsi.

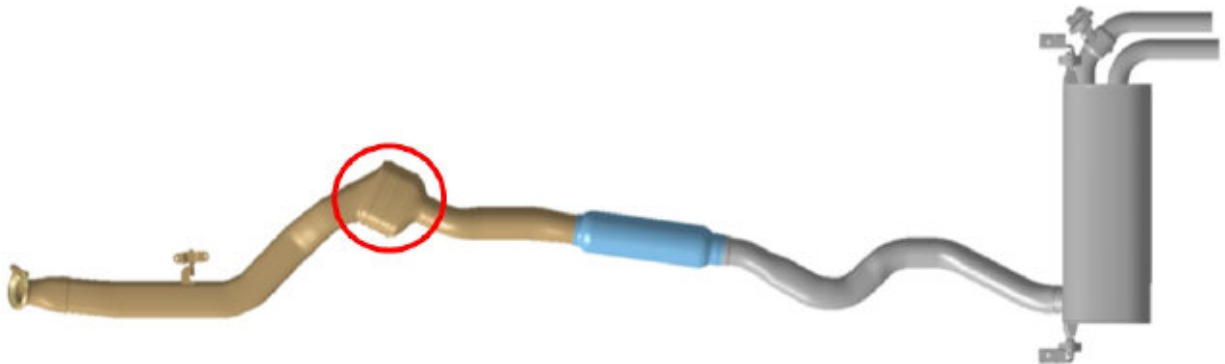

---

## Additional Emission Reduction Measures

### HC Fleece

The air intake system is similar to the M56 and N51 SULEV engines. There is an additional HC fleece filter installed in the air box. This prevents hydrocarbons from escaping to the atmosphere when the engine is at rest. The HC fleece is part of the upper portion of the air box and needs to be replaced as a complete unit if damaged.



### Cooling System

The radiator of the N26 SULEV looks similar to the standard F30 radiator. The surface of the cooling fins are coated with a special “PremAir” coating. The coating consists of multiple porous layers of a catalytic surface. The task of the catalyst coating is to convert Ozone into Oxygen.

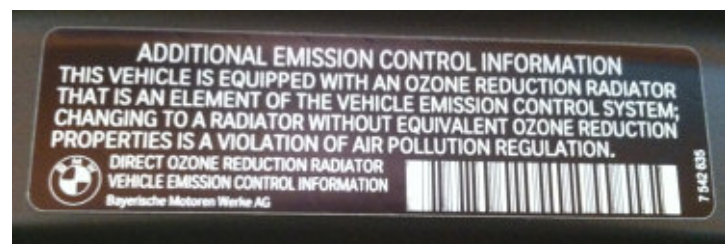
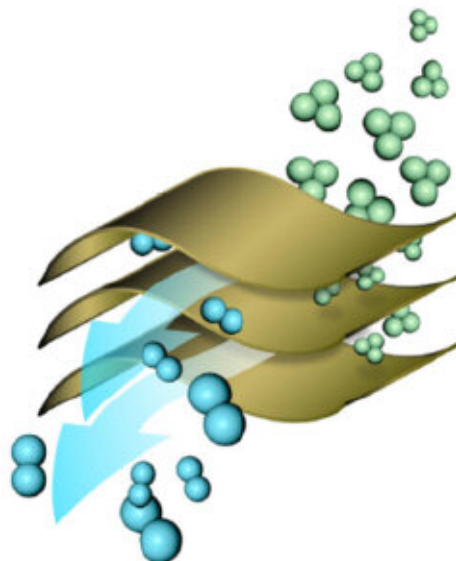

---

## System Overview

The cold start and subsequent catalyst warm-up phase hold the key to meeting the SULEV limits. The majority of all air contaminants are emitted during the first approximately 30 s of the exhaust emission test.

The purpose of the catalyst heating mode at the beginning of the exhaust emission test is to use the exhaust gas to heat the catalytic converter up to light-off temperature as quickly as possible with a minimum of emissions and excellent smooth running. Turbocharged engines constitute a particular challenge in this respect as the exhaust-gas turbocharger acts as an additional heat sink en route to the catalytic converter, thereby delaying light-off accordingly.

The direct injection system with its centrally positioned injector is capable of a much more retarded ignition than can be achieved in an engine with a manifold injection system and it therefore accelerates the catalyst warm-up process considerably.

A lean catalyst heating mode is used with “double injection”. The first injection takes place during the intake phase and contains the main injection volume. It serves to generate a homogeneous, lean basic mixture. The second, lower-volume injection is precipitated as the ignition injection is just after TDC and it accelerates or stabilizes the combustion process by increasing the turbulence in the already ignited basic mixture, enabling the application of a highly retarded ignition. This lean burn mode enables follow-up reactions with the excess oxygen in the exhaust gas, causing the temperature of the exhaust gas to rise and reducing the CO and HC emissions.

Apart from combustion concept optimization, another important prerequisite for compliance with the SULEV values is the minimization of the heat loss by the exhaust gas en route to the catalytic converter. As mentioned above, the turbocharger constitutes a special challenge in its capacity as an additional heat sink upstream of the catalytic converter and causes considerable delay in light off.

The amount of heat loss by the exhaust gas during catalyst heating can be reduced if as much exhaust gas as possible is routed via the wastegate directly, bypassing the turbine. The exhaust gas should also flow through the wastegate ports into the catalytic converter without any direct contact with the walls. The flow to and through the wastegate ports was maximized. The maximum wastegate opening angle is increased from 25° to 45°, using an electric wastegate actuator that also offers other functional advantages.

By implementing these measures, the proportion of exhaust gas routed through the wastegate is considerably increased from 40 to 70%.

## Driving Performance and Fuel Consumption

The SULEV version of BMW's new 2.0-l four-cylinder gasoline engine also offers the dynamic driving performance that is typical of BMW in conjunction with low fuel consumption. The engine delivers a maximum torque of 350 Nm and a maximum power of 180 kW/240 hp. These figures represent a 30% and 4% improvement over the respective values of the predecessor engine. At the same time, the useable engine torque range is greatly enhanced. Compared with its predecessor the N51, the new 328i SULEV boasts significant improvements in driving performance, as well as a substantial reduction in fuel consumption.

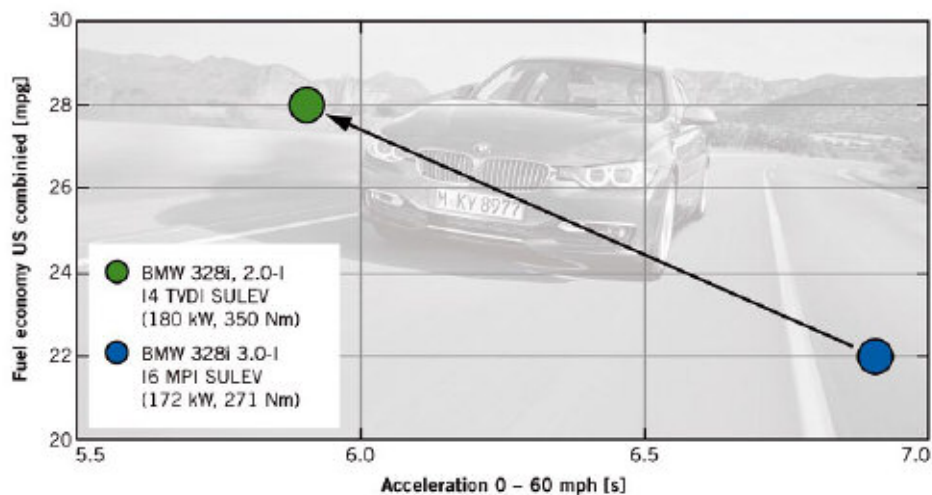

---

NOTES

PAGE